

Guttering and Steel Fascia.



Dress right.



FINISH ON TOP WITH FIELDERS

Gutter Profiles.

All gutters should have a slight fall to the downpipe outlet. (1 in 500). Brackets/Straps spacing – 1.2 m centres.

Fascia Gutter

- High front profile conceals roof tiles and sheet ends (especially useful on roof decking profiles)
- Easily mitred

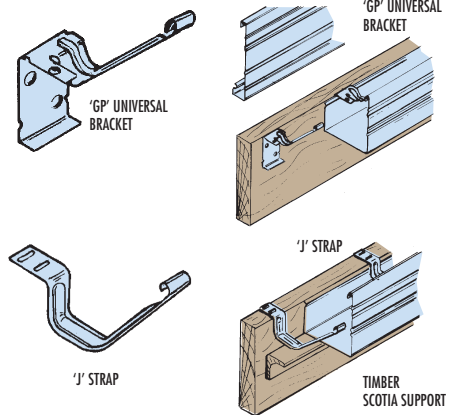
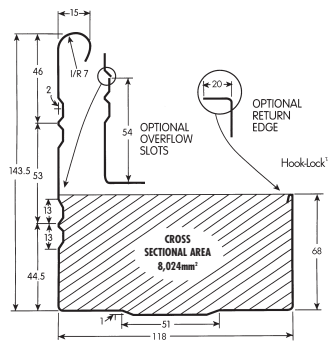
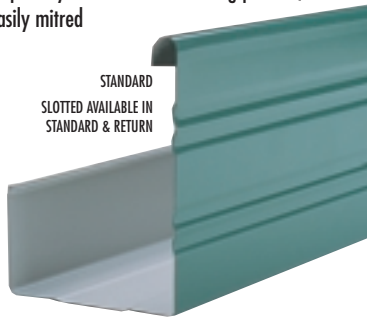

D Gutter

- Stylish adaptable gutter profile
- Blends with older style colonial homes and new home constructions

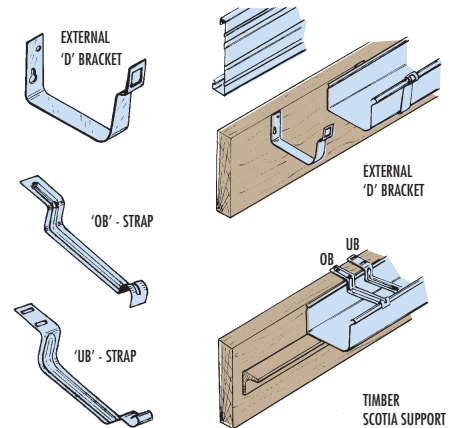
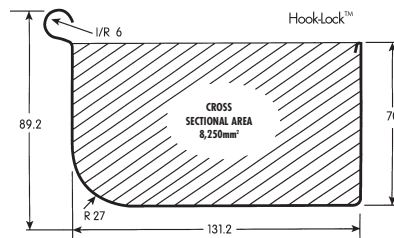

Steel Fascia System.

Fields Zinalume® and Colorbond® Steel Fascia system offers the new home builder an easily installed maintenance free fascia at a fraction of the cost of timber.

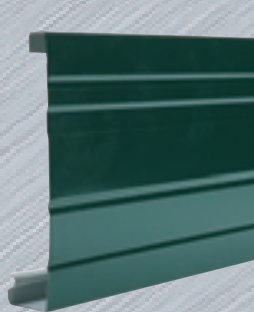

Components

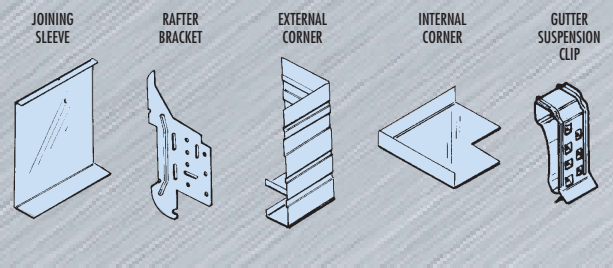

FASCIA COVERING fits easily over old timber or asbestos fascia, lasts for years with –

- NO MAINTENANCE • NO PAINTING • FULL BHP COLORBOND® RANGE

Screws or nails into place. Install guttering with straps as shown.

- ROLLFORM RIBS FOR GREATER STRENGTH



Gutter Profiles.

All gutters should have a slight fall to the downpipe outlet. (1 in 500). Brackets/Straps spacing – 1.2 m centres.

Ainsworth O.G. Gutter

- The high front conceals the bottom of roof tiles or corrugated steel
- Large water carrying capacity

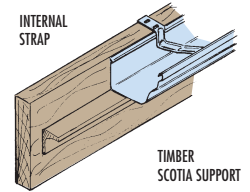
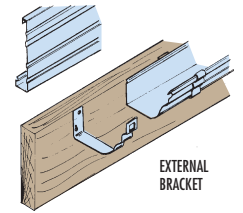
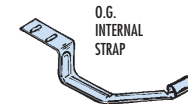
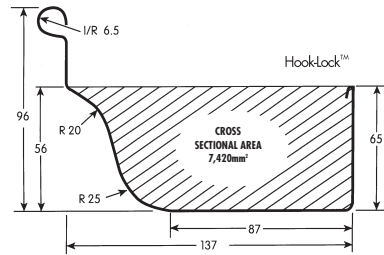
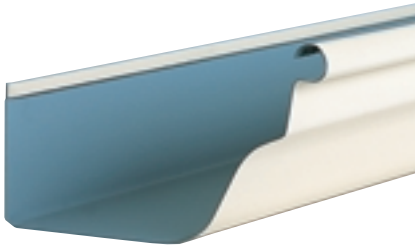

150mm Half Round Gutter

- Spanish style gutter
- Large water carrying capacity
- External brackets allow this gutter to be easily cleaned

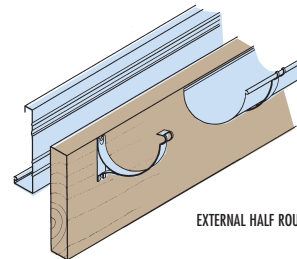
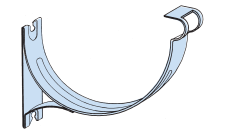
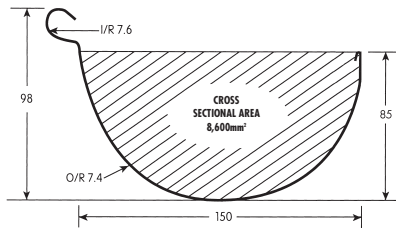

Accessories.

Pre-made Colorbond®, Galvanised or Zinalume® Mitres

Available to suit: Fascia, D, O.G., 150mm Half Round and Halfline Gutter.

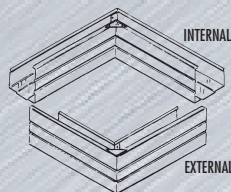

Easyfix Pre-moulded Mitres (Plain or Pre-painted)

Available to suit: O.G., 150mm Half Round and Halfline Gutter.

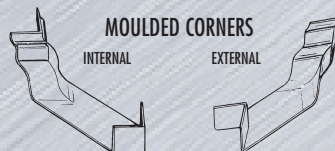

Gutter Stop Ends (Zinalume®, Galvanised or Colorbond® Finish)

Available to suit: Fascia, D, O.G., 150mm Half Round and Halfline Gutter.

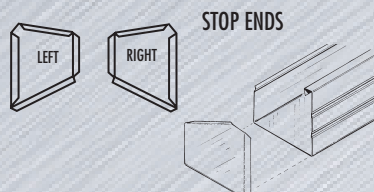

Downpipes.

Standard Sizes

Square downpipes 1800 lengths

50mm x 50mm • 75mm x 50mm • 75mm x 75mm • 100mm x 50mm
100mm x 75mm • 100mm x 100mm • 125mm x 100mm • 150mm x 100mm

Round downpipes 1800 lengths

50mm • 65mm • 75mm • 90mm • 100mm • 125mm • 150mm

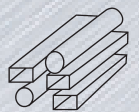

Material Specifications.

(Conforms to AS 1397-2179 & AS 2728)

Zinalume® – AZ150 coating, G300 Tensile strength (Steel Fascia G550).

Colorbond® – pre-painted finish available in the standard XRW Colorbond®.

Colorbond® Stainless and XSE Colorbond® – specially prepared steel for severe environments.

Galvanised – Z275 coating and Z600 double smelted Heritage Galvanised.

British Steel – HPS200.

Gutter Profiles.

All gutters should have a slight fall to the downpipe outlet. (1 in 500). Brackets/Straps spacing – 1.2 m centres.

Halfline Gutter

- Half round in appearance but with all the benefits of modern-style gutters
- Streamline appearance – no external brackets, easily mitred

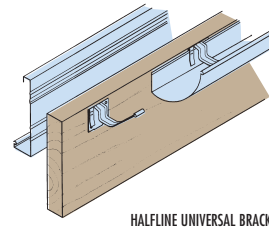
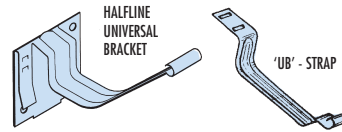
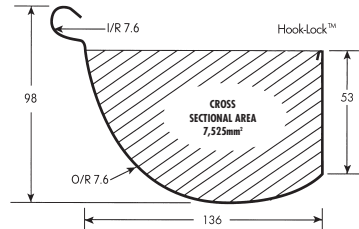

Hi-Tensile Gutters

- Economical
- Traditional style
- Ideal for new home construction and traditional homes
- Optional slotted holes
- Pre-cast mitres available

115MM
QUAD
GUTTER

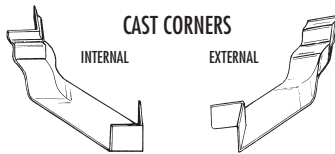
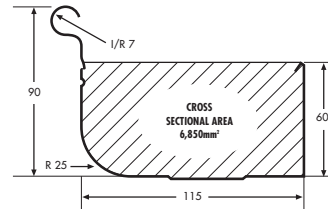

HI-TEN
O.G.
GUTTER

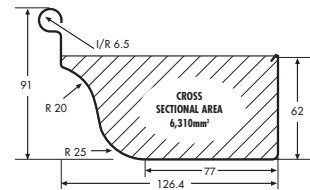
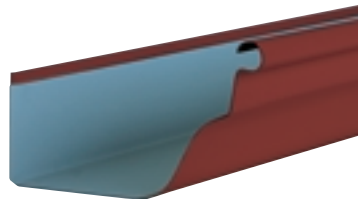

90° and 135° Cast Corners (Plain or Pre-painted)
Available to suit: Hi-Tensile 115mm Quad and Hi-Ten OG.

Downpipe Accessories.

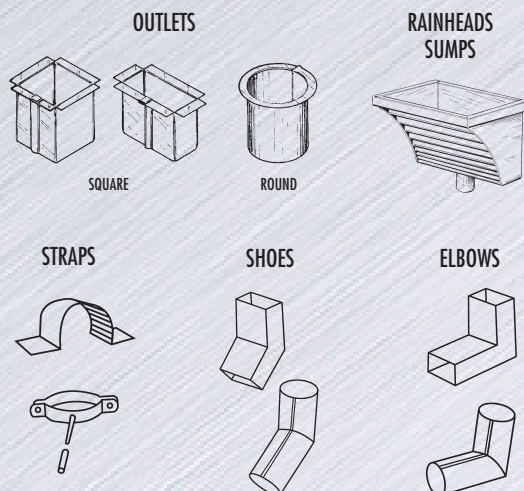

WaterGate®.

- Suitable for tile and corrugated roofing
- Prevents leaves from entering the gutter
- Lowers the fire risk
- Helps prevent overflowing of gutters
- Easily installed to new or existing gutters
- Unique clipping design
- Long life – made from high strength Zinalume®
- Fits all popular gutter profiles
- Well concealed – won't spoil the appearance of your house

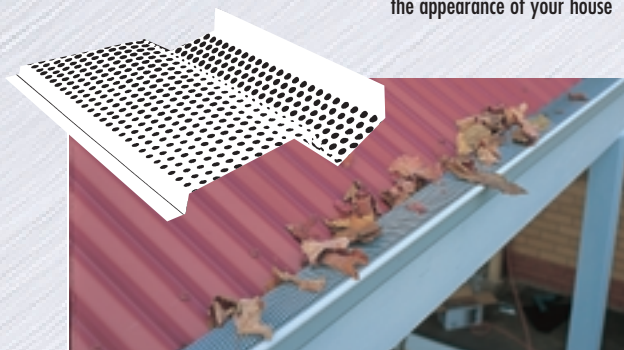

Available profiles.

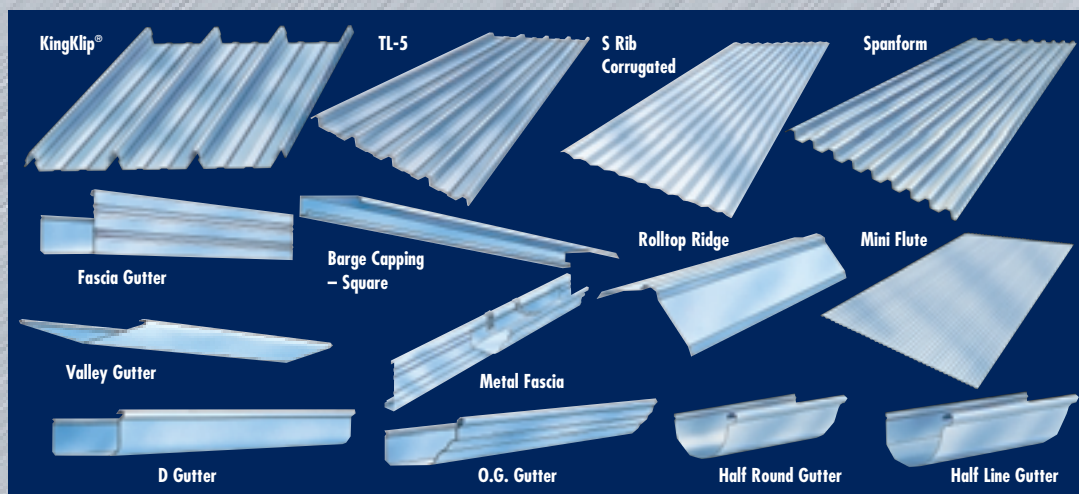

Fielders Watertight Installation Guarantee.

Insist on the best guarantee available – A Fielders Guarantee ensures owners receive the roof cover they deserve.

Fielders Steel Roofing gives the building owner a written guarantee.



5 Year Watertight Installation Guarantee on screw fix roofing products and the completed installation.



20 Year Watertight Installation Guarantee on KingKlip® concealed fix roof sheeting and the completed installation.

Fielders also provides corrosion and paint performance warranties on the steel sheeting:

- Up to 25 years for BHP Zinalume® based products.
- 10 years for Z600 Heritage Galvanised – the only galvanised guarantee in Australia.
- A Fielders Maintenance Contract extends the guarantee by 5 years.

Steps to obtain the Watertight Installation Guarantee are as follows.

Prior to the commencement of the project, complete a registration form (available from Fielders).

This may be completed by the owner of the building, architect, designer or engineer.

Compliance with the following three easy steps, will ensure you receive the job you expect and deserve – guaranteed:

1. Specify and use Fielders Roofing, Walling and Accessories.
2. Specify and use a Fielders Approved Contractor.
3. Specify a Fielders Watertight Installation Guarantee – don't leave it to chance.

**Zinalume®
Colorbond®**



FINISH ON TOP WITH FIELDERS

* Colorbond® and Zinalume® are registered trademarks of BHP Steel.

**For more information
on Fielders products
call NOW on
1800 182 255!**



FINISH ON TOP WITH FIELDERS